

Varenummer: 2302002512
Beskrivelse: E+G Fingermøtrik
B.193/30 FP-M8

Mål

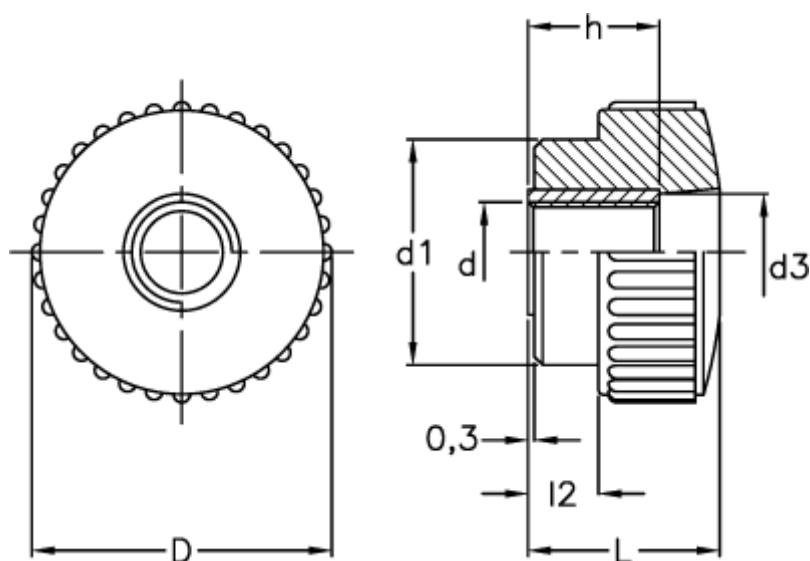

D	= 31
d1	= 24
d3	= 13
d 6H	= M8
h	= 15
L	= 18.0
l2	= 6